

# Micro Raman system

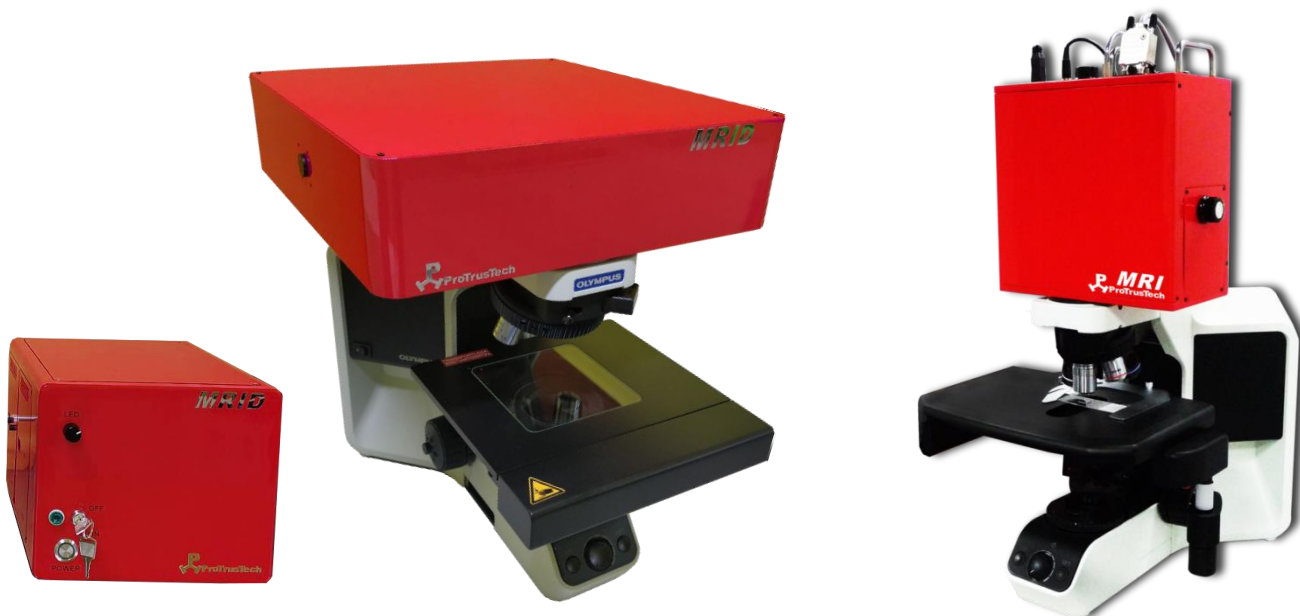

# MRID Spectrometer

**MRID** (Micro Raman Identification Dual Lasers)

**MRID** is a microscopic Raman system inbuilt with two lasers automatically switchable by software. This design is granted a Taiwan invention patent I709732 and USA invention patent US 11,340,114 B2. It solves the trouble of optimizing the optical path each time a different laser wavelength is used, and in turn provides a highly reliable optical system that users without optical backgrounds could also handle with ease.

A third laser module or more could be integrated into MRID system thanks to its horizontal interlace design for the optical path. With two of the lasers built in and fixed, the additional laser module(s) connected via optical fiber are swappable and configurable by the users, facilitating a wider range of applications.(customization)

## Dual-Wavelength Acquisition

One click to automatically measure the spectra excited by different wavelengths is another PTT proprietary feature. The two spectra acquired automatically below show at  $520\text{ cm}^{-1}$  as well as NIR range the silicon chip behaves differently under 785-nm and under 532-nm lasers. This feature could also acquire both Raman and Photoluminescence signals respectively and automatically from the same excitation source.

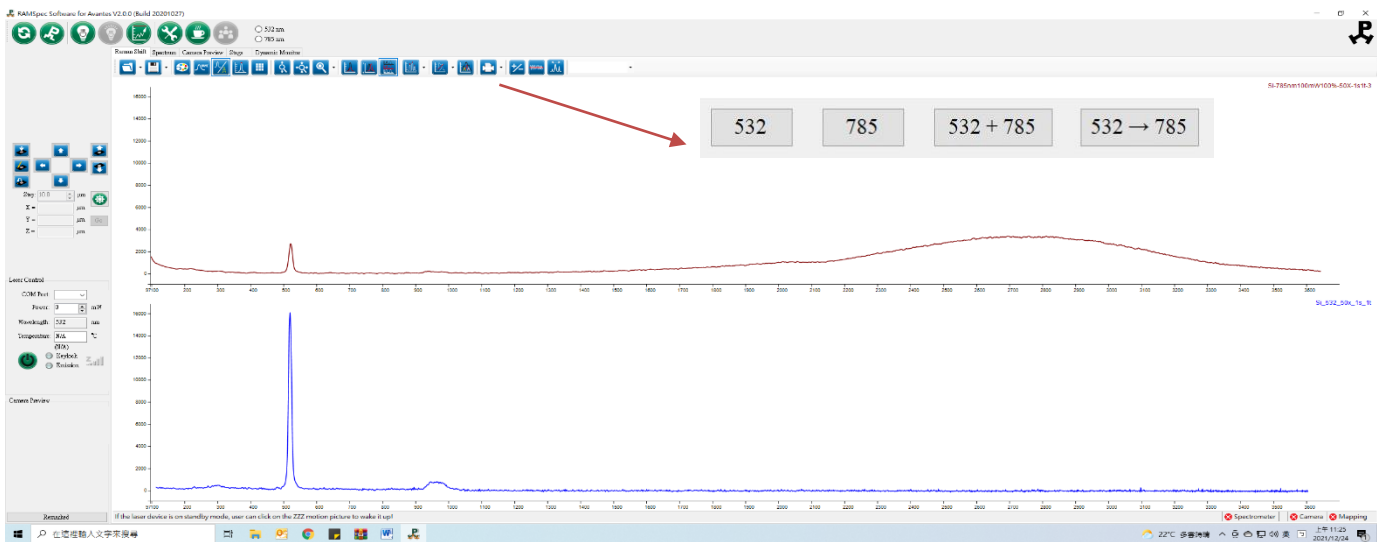

## The power of laser output error less 1%

Laser power output could be directly controlled by software, at 1 mW/step for RGB Lasersystems, one of the major laser brands used in MRID. In addition, system can accurately control the laser power error less 1% because of built-in calibration for different laser light source.

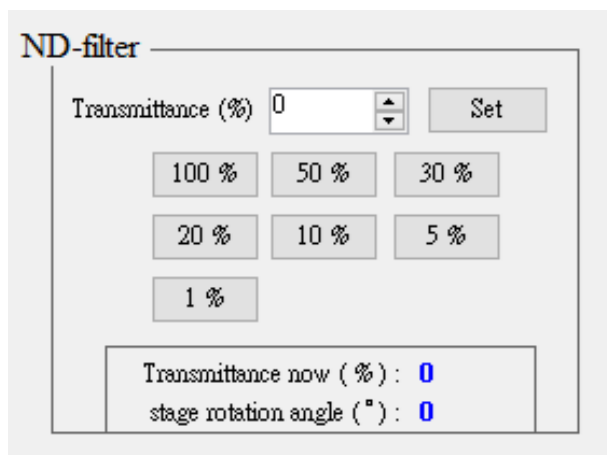

ND control : User-input & frequently used transmission

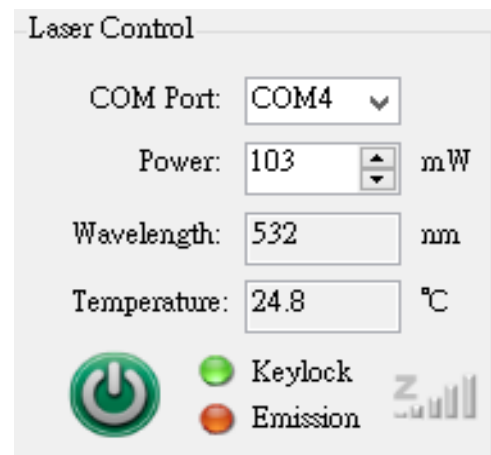

Laser control : User input, 1mW/step

## RPRM Module (Optional)

**RPRM**(Raman **P**olarization **R**otating **M**apping) Different alignment of optical axis with respect to the incident laser polarization can lead to different spectra for anisotropic samples, such as strained films or crystals. The polarization feature facilitates the observation of such properties by controlling both directions via **M**APM.

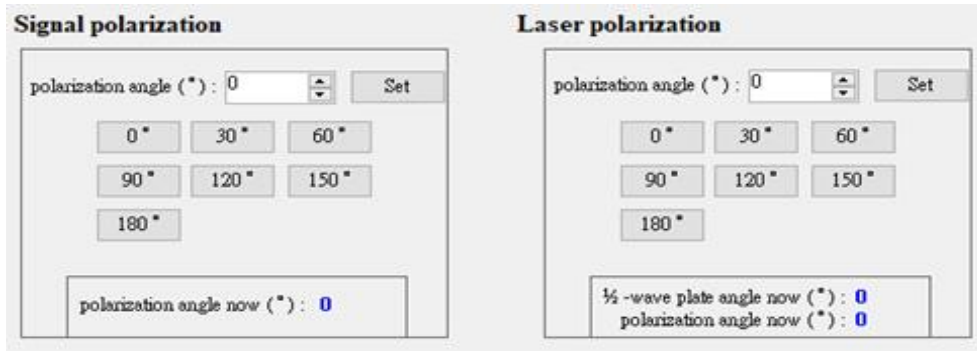

## Exposure Control for Scan/View Switch

When observing samples, the laser power is reduced to lower than 0.01% so as to keep the image from overexposure. Such switch between SCAN and VIEW modes is automatically completed by software, avoiding manual vibration from shifting the sample and ensuring precision of both the position and the focus.

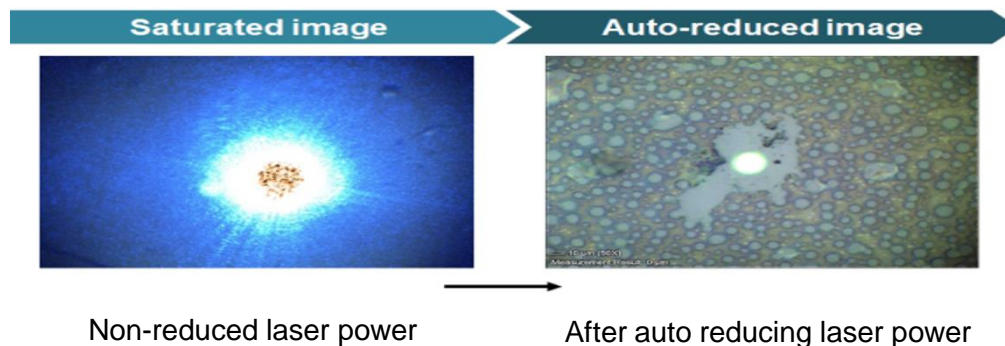

## Raman Mapping(Optional)

Advanced Raman mapping feature, with the XY motorized stage

- 75 X 50 mm or 100 X 100 mm
- Resolution 0.01  $\mu\text{m}$  (smallest step size)@XY
- Resolution typical 0,002  $\mu\text{m}$  @Z
- Depend on the weight of sample

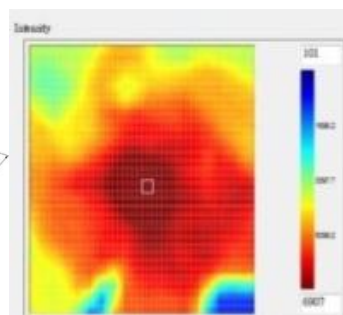
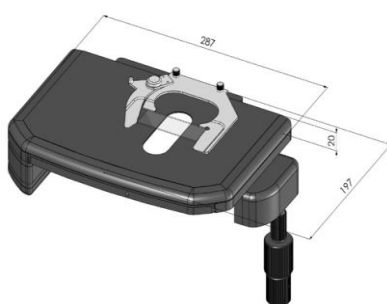

## 4-Point Probe / Temperature Control (Optional)

- Vacuum temperature control : -196 ~ 350/600°C
- Heating stage : up to 1500°C
- Four-point probe measurements

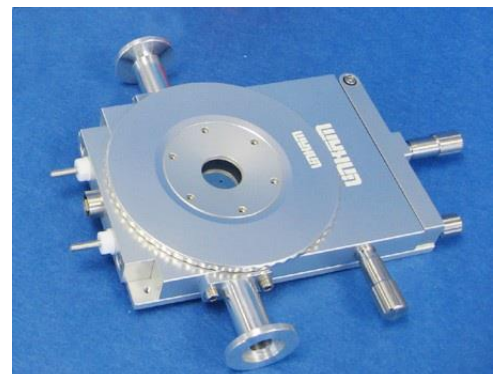

# MRI Spectrometer

## MRI (Micro Raman Identification)

MRI is a compact and modularized micro Raman system whose laser could be easily swapped with other lasers of different wavelengths. Its optical path could also be optimized accordingly by the users without difficulty. This design, granted Taiwan invention patents (I570402, I593953) as well as a US utility patent (US 10,247,674 B2), further enables Raman measurements at flexible angles and in difficult positions.



Measurements at flexible angles



Adjustable optical path for optimization

## STM TERS (Upgrade, Taiwan only )

STM is ideal for **T**ip-**E**nhanced **R**aman **S**cattering (**TERS**) as its tip apex could create a hotspot offering a strong signal enhancement without interfering with the excitation light. The high flexibility and compatibility of our MRI design allows it to integrate seamlessly with the STM.

The resolution of chemical imaging in our system is also enhanced to the level of tens of nanometers thanks to STM's superior spatial resolution, offering a wider applications in semiconductor, advanced materials, as well as in life sciences, including biological or protein based samples, bacteria and viruses

## Reference Specifications

- MRID system is inbuilt with two lasers of your selected wavelengths at 375, 405, 473, 532, 633, 785, 808 and 830 nm based on your needs for either Raman or Photoluminescence spectroscopy. The adopted micro design lasers are made by highly reliable RGB Lasersystems.
- Our basic transverse electromagnetic mode ( $TEM_{00}$ ) offers excellent beam quality. The most commonly seen 532-nm laser beam size is approx. 2~3  $\mu\text{m}$  on the sample surface through a 100X objective lens. Available objective lenses include 10X, 40X, 50X, 100X, etc.
- Spectral range is customizable. With the use of high performance edge filter cut off at  $50\text{ cm}^{-1}$ , the resulting resolution is  $1.8\text{ cm}^{-1}$  for the spectral range of  $79 \sim 3500\text{ cm}^{-1}$  or  $1.3\text{ cm}^{-1}$  for the range of  $79 \sim 2100\text{ cm}^{-1}$ .

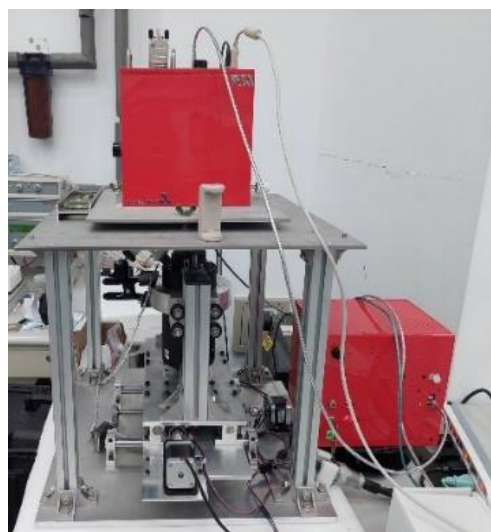

## Contact ProTrusTech Co., Ltd

**ADD:** 3F-1, No.293, Sec. 3, Dongmen Rd. East District  
, Tainan City 701 Taiwan  
**TEL:** 886-6-2892081 **FAX:** 886-6-2890862  
**E-mail:** ad@protrustech.com  
**Website:** <https://www.ProTrusTech.com>



Website

## Distributor